

# PV3 LED SOLAR STREET LIGHT



## AREAS OF APPLICATION

- Off-Grid Areas
- Urban & Residential Streets & Roads
- Car Parks
- Squares & Pedestrian Areas
- Bike & Pedestrian Paths
- Security Lighting



## PRODUCT BENEFITS

- All in One design, easy for installation
- Smart MPPT controller realizes intelligent control of lamps
- Monocrystalline silicon solar panels, greatly improving solar energy conversion efficiency
- Deep cycle lithium battery, charge and discharge over 2,000 times
- Equipped with infrared or motion sensors, effectively save energy
- Adjustable mounting brackets ensure optimal sunlight exposure angle
- Continuously work 5-7 autonomy days in intelligent mode

## PRODUCT FEATURES

- Luminaire efficacy: up to 210 lm/W
- Optic Lens: Type II, Type III, Type V
- Type of protection: IP65
- Impact resistance: IK10
- Working Temperature: -20°C~+60°C



## TECHNICAL DEFINITIONS

### Lithium Battery



Lithium based battery packs have the added advantage that they have a higher power density than lead, which means they have more available power for the same mass of a lead battery. This advantage, combined with the longer life expectancy and higher rate of depth of discharge (DOD), offering an attractive option for solar lighting applications, resulting in a longer battery lifetime. Renowned branded cells used in lighting ensure the highest quality product. In addition, all Lithium ion battery packs have an integrated Battery Management System (BMS) which monitors the health, charging and discharging of the battery pack. This safeguards the cells so that they are not over charged or discharged, maximising their lifetime.

### Solar module

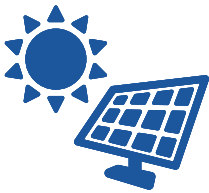

The solar panels are ISO and TUV certified and carry a 25-year product lifetime. Hail-resistant and corrosion-proof. Rated outputs on the panels are 90% minimum for the first 10 years and 80% minimum after 25 years.

### Charge controller

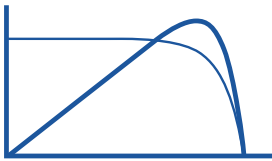

The MPPT charge controllers can harvest up to 30% more energy in clouded sky conditions compared to PWM charge controllers. The charge controllers have a load output connection that can be programmed to switch the luminaires off when the battery voltage drops to critical levels. This allows for the batteries to be protected from over discharge. The charge controllers have integrated temperature sensors that can compensate for thermal environmental changes when charging the batteries. The charge controllers use a 3-step charging process with all three charge levels programmable depending on the battery technology selected.

### Optidim



Intelligent luminaire drivers are programmed if required in the factory with complex dimming profiles. Up to 5 combinations of time intervals and light levels are possible. This feature does not require any extra wiring. The period between switching on and switching off is used to activate the preset dimming profile.

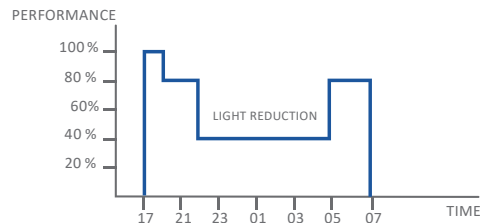

### Autonomy Days



Autonomy Days refers to the number of nights/cycles a luminaire will continue to work without receiving a charge/ being charged from the solar panel, due to overcast weather conditions. The number of autonomy days is aligned to the battery depth of discharge resulting in sufficient capacity after a night/cycle.

**KEY FEATURES**

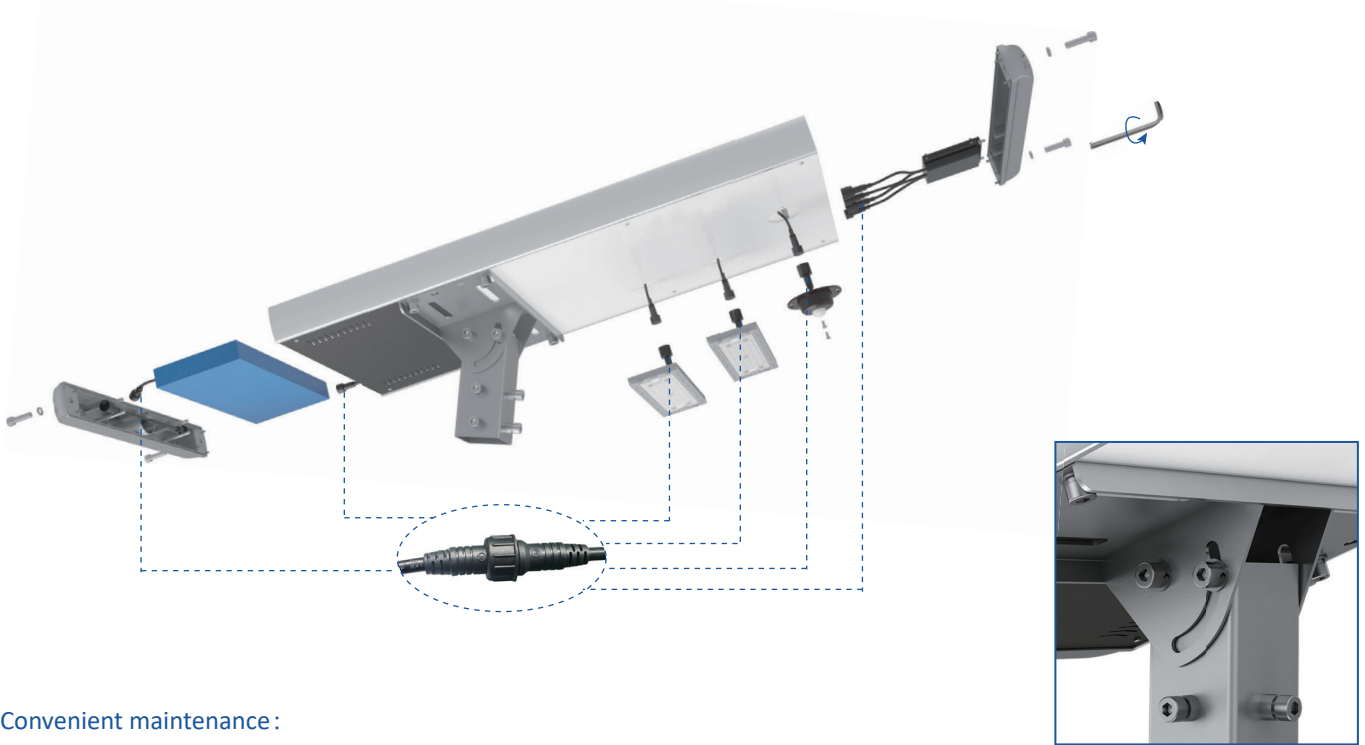

**Convenient maintenance :**

- + Drawer design makes the battery, led modules, sensor and controller easier to maintain.
- + Male /Female IP68 cable connector makes the luminaire waterproof and easy to replace.

Angle of Mounting bracket: 0-90°

**OPTICS**

**Type II**

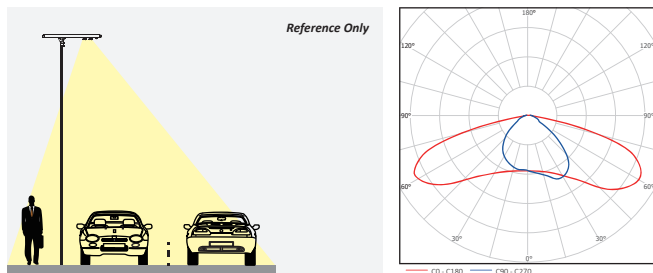

**Type III**

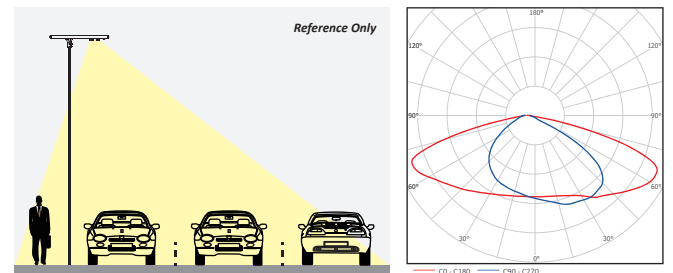

**Type V**

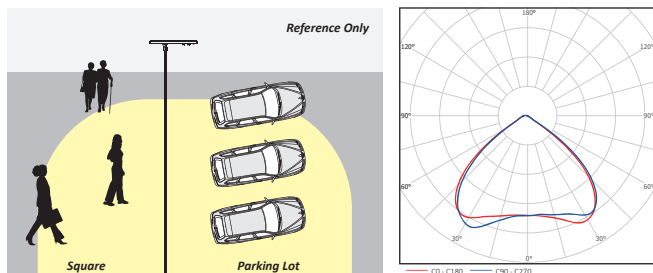

**PRODUCT DATASHEET**

**Electrical & Photometric**



**50W Monocrystal**

Model	Power	Equivalent to competing products	Modules Qty	Effcacy (+/- 5%)	Lumen (+/- 5%)	Battery Spec. (Lithium)	Constant worktime at 100% power	Constant worktime at 30% power (Energy save mode)	Charge Time	Installation Height	Pole Distance
ZGSM-PV501010	10W	15-20 W	1 (32 LEDs)	210 lm/ w	2100 lm	111WH	8.5 Hours	>29 Hours	2.5 Hours	3~4m	9~14m
ZGSM-PV501510	15W	25-30 W	1 (32 LEDs)	208 lm/ w	3120 lm	111WH	5.5 Hours	>19.5 Hours	2.5 Hours	3~5m	9~17m
ZGSM-PV502010	20W	30-40 W	1 (32 LEDs)	205 lm/ w	4100 lm	111WH	4 Hours	>14.5 Hours	2.5 Hours	4~5m	12~17m
ZGSM-PV502020	20W	30-40 W	1 (32 LEDs)	205 lm/ w	4100 lm	222WH	8.5 Hours	>29 Hours	4.5 Hours	4~5m	12~17m
ZGSM-PV503020	30W	50-60 W	2 (64 LEDs)	208 lm/ w	6240 lm	222WH	5.5 Hours	>19.5 Hours	4.5 Hours	4~6m	12~21m
ZGSM-PV504020	40W	65-80 W	2 (64 LEDs)	205 lm/ w	8200 lm	222WH	4 Hours	>14.5 Hours	4.5 Hours	5~6m	15~21m
ZGSM-PV504027	40W	65-80 W	2 (64 LEDs)	205 lm/ w	8200 lm	300WH	6 Hours	>20 Hours	6 Hours	5~6m	15~21m
ZGSM-PV505027	50W	80-100 W	2 (64 LEDs)	200 lm/ w	10000 lm	300WH	4.5 Hours	>16 Hours	6 Hours	5~7m	15~25m



**70W Monocrystal**

Model	Power	Equivalent to competing products	Modules Qty	Effcacy (+/- 5%)	Lumen (+/- 5%)	Battery Spec. (Lithium)	Constant worktime at 100% power	Constant worktime at 30% power (Energy save mode)	Charge Time	Installation Height	Pole Distance
ZGSM-PV702020	20W	30-40 W	2 (64 LEDs)	210 lm/ w	4200 lm	222WH	8.5 Hours	>29 Hours	3.5 Hours	4~5m	12~17m
ZGSM-PV703020	30W	50-60 W	2 (64 LEDs)	208 lm/ w	6240 lm	222WH	5.5 Hours	>19.5 Hours	3.5 Hours	4~6m	12~21m
ZGSM-PV703027	30W	50-60 W	2 (64 LEDs)	208 lm/ w	6240 lm	300WH	8 Hours	>26 Hours	4.5 Hours	4~6m	12~21m
ZGSM-PV704020	40W	60-80 W	2 (64 LEDs)	205 lm/ w	8200 lm	222WH	4 Hours	>14.5 Hours	3.5 Hours	5~6m	15~21m
ZGSM-PV704027	40W	60-80 W	2 (64 LEDs)	205 lm/ w	8200 lm	300WH	6 Hours	>20 Hours	4.5 Hours	5~6m	15~21m
ZGSM-PV704040	40W	60-80 W	2 (64 LEDs)	205 lm/ w	8200 lm	444WH	8.5 Hours	>29.5 Hours	6.5 Hours	5~6m	15~21m
ZGSM-PV705027	50W	80-100 W	3 (96 LEDs)	206 lm/ w	10300 lm	300WH	4.5 Hours	>16 Hours	4.5 Hours	5~7m	15~25m
ZGSM-PV705040	50W	80-100 W	3 (96 LEDs)	206 lm/ w	10300 lm	444WH	7 Hours	>23.5 Hours	6.5 Hours	5~7m	15~25m
ZGSM-PV706027	60W	95-120 W	3 (96 LEDs)	205 lm/ w	12300 lm	300WH	4 Hours	>13 Hours	4.5 Hours	6~8m	18~35m
ZGSM-PV706040	60W	95-120 W	3 (96 LEDs)	205 lm/ w	12300 lm	444WH	5.5 Hours	>19.5 Hours	6.5 Hours	6~8m	18~35m

**PRODUCT DATASHEET**

**100W Monocrystal**

Model	Power	Equivalent to competing products	Modules Qty	Efficacy (+/- 5%)	Lumen (+/- 5%)	Battery Spec. (Lithium)	Constant worktime at 100% power	Constant worktime at 30% power (Energy save mode)	Charge Time	Installation Height	Pole Distance
ZGSM-PV1003020	30W	50-60 W	3 (96 LEDs)	210 lm/ w	6300 lm	222WH	5.5 Hours	>19.5 Hours	2.5 Hours	4~6m	12~21m
ZGSM-PV1003027	30W	50-60 W	3 (96 LEDs)	210 lm/ w	6300 lm	300WH	8 Hours	>26.5 Hours	3 Hours	4~6m	12~21m
ZGSM-PV1004020	40W	65-80 W	3 (96 LEDs)	209 lm/ w	8360 lm	222WH	4 Hours	>14.5 Hours	2.5 Hours	5~6m	15~21m
ZGSM-PV1004027	40W	65-80 W	3 (96 LEDs)	209 lm/ w	8360 lm	300WH	6 Hours	>20 Hours	3 Hours	5~6m	15~21m
ZGSM-PV1004040	40W	65-80 W	3 (96 LEDs)	209 lm/ w	8360 lm	444WH	8.5 Hours	>29.5 Hours	4.5 Hours	5~6m	15~21m
ZGSM-PV1005027	50W	80-100 W	3 (96 LEDs)	206 lm/ w	10300 lm	300WH	4.8 Hours	>16 Hours	3 Hours	5~7m	15~25m
ZGSM-PV1005040	50W	80-100 W	3 (96 LEDs)	206 lm/ w	10300 lm	444WH	7 Hours	>23.5 Hours	4.5 Hours	5~7m	15~25m
ZGSM-PV1005045	50W	80-100 W	3 (96 LEDs)	206 lm/ w	10300 lm	500WH	8 Hours	>26.5 Hours	5 Hours	5~7m	15~25m
ZGSM-PV1006027	60W	95-120 W	3 (96 LEDs)	205 lm/ w	12300 lm	300WH	4 Hours	>13 Hours	3 Hours	6~8m	18~35m
ZGSM-PV1006040	60W	95-120 W	3 (96 LEDs)	205 lm/ w	12300 lm	444WH	5.5 Hours	>19.5 Hours	4.5 Hours	6~8m	18~35m
ZGSM-PV1006045	60W	95-120 W	3 (96 LEDs)	205 lm/ w	12300 lm	500WH	6.5 Hours	>22 Hours	5 Hours	6~8m	18~35m

**Dimension & Weight**

Solar Panel	Model	Body /Base Carton Size (mm)	N.W (kg)	Body /Base G.W (kg)
Monocrystal 50W	ZGSM-PV501010 /ZGSM-PV501510 /ZGSM-PV502010	915 x485 x140 /410 x160 x205	14.8	11.9/ 5.2
	ZGSM-PV502020		15.9	13.0/ 5.2
	ZGSM-PV503020 /ZGSM-PV504020		16.3	13.4/ 5.2
	ZGSM-PV504027 /ZGSM-PV505027		17.5	14.6/ 5.2
Monocrystal 70W	ZGSM-PV702020 /ZGSM-PV703020 /ZGSM-PV704020	1175 x485 x140 /410 x160 x205	17.8	15.3/ 5.2
	ZGSM-PV703027 /ZGSM-PV704027		19.0	16.4/ 5.2
	ZGSM-PV704040		20.0	17.4/ 5.2
	ZGSM-PV705027 /ZGSM-PV706027		19.4	16.8/ 5.2
	ZGSM-PV705040 /ZGSM-PV706040		20.4	17.8/ 5.2
Monocrystal 100W	ZGSM-PV1003020 /ZGSM-PV1004020 /ZGSM-PV1003027 /ZGSM-PV1004027 /ZGSM-PV1005027 /ZGSM-PV1006027	1665 x485 x140 /410 x160 x205	23.8	22.1/ 5.2
	ZGSM-PV1004040 /ZGSM-PV1005040 /ZGSM-PV1006040		24.8	23.1/ 5.2
	ZGSM-PV1005045 /ZGSM-PV1006045		26.0	24.3/ 5.2

Note: Above data of weight are all typical values.

**DIMENSION**

**50W Monocrystal**

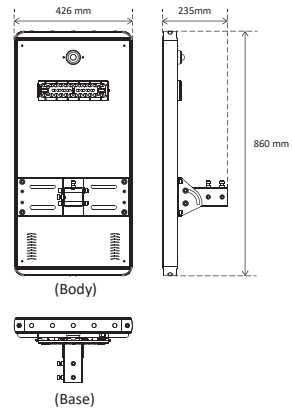

**70W Monocrystal**

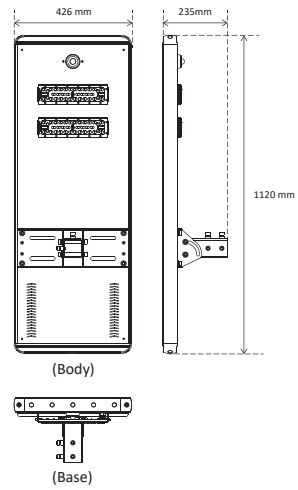

**100W Monocrystal**

